

## FELCO 9 Classic

Pruning shear - High performance - Ergonomic - Left-hand version

Made in Switzerland by FELCO



25mm/1in.



S L



L R



210mm/8.3in.



245g/8.6oz.



7 83929 10007 4

- **Reliable:** comfortable, light, sturdy handles made of forged aluminium with a lifetime guarantee\* / blade and screw-mounted anvil blade made of high-quality hardened steel / clean, precise cut / all parts can be replaced
- **Efficient:** easy, durable cutting adjustment / wire cutting notch / sap groove
- **Ergonomic:** hand and wrist protection and optimisation of the force exerted are provided by the ideal shape of the handles, the angled head and the cushion-shock absorber / non-slip coating

Our recommendation (1 ★: Recommended, 2 ★: Strongly recommended, 3 ★: Best fit)

Viticulture	★★★
Arboriculture	★★★
Horticulture	★★★
Parks and Gardens	★★★
Nursery	★★★
Small hand	★★★
Large hand	★★★
Left-handed	★★★

---

## The points of excellence



### Forged aluminium handles guaranteed for life\*

Lightweight, strong and sturdy thanks to special aluminium alloys and advanced precision forging methods perfectly mastered by FELCO.



### Ergonomic tool

Inclined cutting head to reduce the risk of muscular-skeletal injuries and to maximise user comfort.

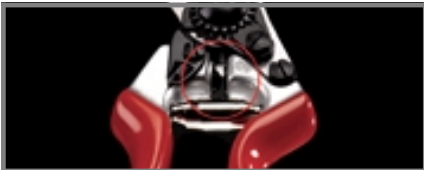

### Shock absorption system

FELCO's special cushion stops reduce impact at the end of a cut, protecting hand and wrist.

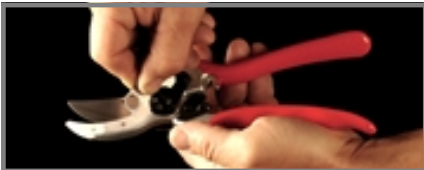

### Precision adjustment system

FELCO's micrometric adjustment system guarantees an optimal adjustment of the cutting head throughout the life of the tool, and delivers a clean and precise cut every time.



### Sap groove

The sap groove prevents the blade sticking when cutting "sappy" wood. It saves time and makes pruning easier by removing sap and debris after each cut.



### Wire cutting notch

The blades of most FELCO pruning shears feature a notch that allows for the cutting of small wires without damaging the cutting edge.

## Accessories



FELCO 300

Picking and Trimming Snip

For a clean cut



FELCO 310

Picking and Trimming Snip

For grape harvesting



FELCO 902

Sharpening tool

Sharpening stone



FELCO 903

Sharpening tool

Sharpener



FELCO 910

Holster

Leather - With belt loop and clip



FELCO 912

Holster

Leather - With belt clip



FELCO 913

Holster

In mock leather - With belt loop



FELCO 980

Maintenance product

Spray











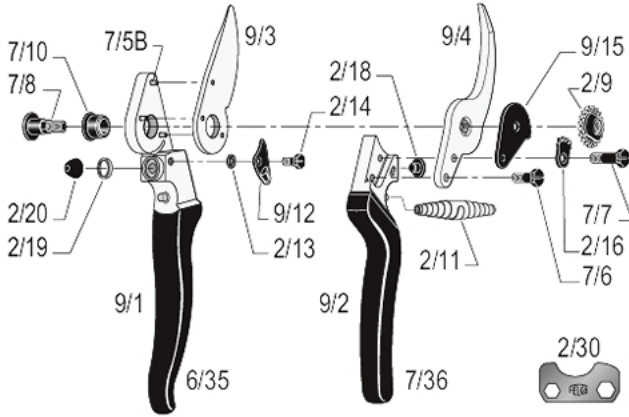







FELCO 990

















Maintenance product

Grease

Spare parts



	REF.	Designation	Composition	UCC bar code
	2/30	Adjustment key	1x 2/30	
	9/3	Blade	1x 9/3	
	9/4	Anvil-blade with screw	1x 9/4 + 1x 7/6	
	7/90	Kit	1x 7/7 + 1x 2/16 + 1x 2/9 + 1x 7/8	
	2/91	Kit	2x 2/11	
	2/93	Kit	4x 2/18 + 6x 2/20	
	7/94	Kit	1x 2/9 + 1x 7/8	
	9/1	Handle without blade	1x 9/1 + 3x 7/5B + 1x 2/19 + 1x 2/20 + 1x 7/10 + 1x 2/13 + 1x 9/12 + 1x 2/14 + 1x 7/35	
	9/2	Handle without anvil-blade	1x 9/2 + 1x 2/18 + 1x 7/36	

	6/35	Plastic coating for blade handle	1x 6/35
	7/36	Plastic coating for anvil-blade / anvil handle	1x 7/36
	7/5B	Rivet for blade	1x 7/5B
	7/6	Screw for anvil-blade	1x 7/6
	7/8	Bolt	1x 7/8
	2/9	Nut	1x 2/9
	7/10	Bush	1x 7/10
	2/11	White spring	1x 2/11
	9/12	Thumb catch	1x 9/12
	2/13	Spring for thumb catch	1x 2/13
	2/14	Screw for thumb catch	1x 2/14
	9/15	Catch plate	1x 9/15
	2/16	Locking segment	1x 2/16
	7/7	Screw for locking segment	1x 7/7
	2/18	Cushion	1x 2/18
	2/19	Edging	1x 2/19
	2/20	Shock absorber	1x 2/20

## Maintenance



### Cleaning

It is advisable to clean your tool after each use.

If your tool is particularly dirty or subject to rusting after exposure to moisture, do not delay cleaning.



### Oiling

After cleaning, it is advisable to oil the tool so as to protect it from corrosion. The oil will also unjam the tool.



### Sharpening

It is advisable to sharpen your tool at least once a day, but if you feel that your tool is not cutting as well as usual, sharpen it right away!



### Dismantling

It is advisable to dismantle your tool on a regular basis, but at the very latest when it appears to be jammed.

## Replacement parts



### Changing the blade

When the blade and the anvil-blade no longer cross, or when the blade is badly damaged, it is advisable to change it.

Regulate the working of the blade and anvil-blade by adjusting the tightening of the nut. The blade should rub against the anvil-blade over 2/3 of its length.



### Changing the anvil-blade

When the blade and anvil-blade no longer cross and the anvil-blade is badly damaged, it is advisable to change it.



### Changing the shock absorber

When the tool closes too abruptly during pruning, and the cushion is in good condition, the shock absorber should be changed.



### Changing the cushion

When the tool closes too abruptly during pruning and the shock absorber is in good condition, the cushion must be changed.



### Changing the thumb catch

When the thumb catch is damaged and loosens when used, even when the screw is readjusted, change it.



### Changing the plastic coatings for handles

If the coatings are badly damaged, you can replace them.

Soak the coatings for 2 minutes in boiling water - recommended glue: Loctite 415.