

FELCO 7 Classic

Pruning shear - High performance - Ergonomic

Made in Switzerland by FELCO

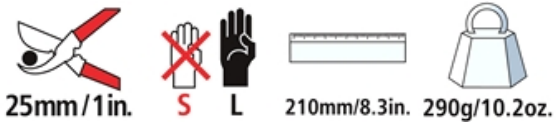

- **Reliable:** comfortable, light, sturdy handles made of forged aluminium with a lifetime guarantee* / blade and screw-mounted anvil blade made of high-quality hardened steel / clean, precise cut / all parts can be replaced
- **Efficient:** easy, durable cutting adjustment / wire cutting notch / sap groove
- **Ergonomic:** hand and wrist protection, and optimisation of the force exerted are provided by the revolving handle, the angled head and the cushion-shock absorber / non-slip coating

Our recommendation (1 ★: Recommended, 2 ★: Strongly recommended, 3 ★: Best fit)

Viticulture	★★★
Arboriculture	★★★
Horticulture	★☆☆
Parks and Gardens	★★★
Nursery	★☆☆
Small hand	☆☆☆
Large hand	★★★
Left-handed	☆☆☆

The points of excellence



Forged aluminium handles guaranteed for life*

Lightweight, strong and sturdy thanks to special aluminium alloys and advanced precision forging methods perfectly mastered by FELCO.



Ergonomic tool

Inclined cutting head to reduce the risk of muscular-skeletal injuries and to maximise user comfort.



Revolving handle

The revolving handle spreads muscular effort across all fingers and reduces the overall cutting effort by 30%. This FELCO invention reduces the risk of both tendonitis (RSI) and carpal tunnel syndrome.

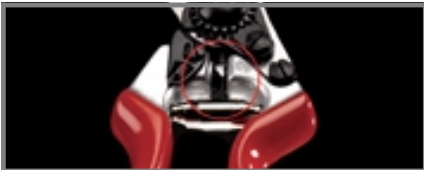

Shock absorption system

FELCO's special cushion stops reduce impact at the end of a cut, protecting hand and wrist.



Precision adjustment system

FELCO's micrometric adjustment system guarantees an optimal adjustment of the cutting head throughout the life of the tool, and delivers a clean and precise cut every time.



Precision adjustment system

FELCO's micrometric adjustment system guarantees an optimal adjustment of the cutting head throughout the life of the tool, and delivers a clean and precise cut every time.



Sap groove

The sap groove prevents the blade sticking when cutting "sappy" wood. It saves time and makes pruning easier by removing sap and debris after each cut.



Wire cutting notch

The blades of most FELCO pruning shears feature a notch that allows for the cutting of small wires without damaging the cutting edge.

Accessories



FELCO 300

Picking and Trimming Snip
For a clean cut



FELCO 310

Picking and Trimming Snip
For grape harvesting



FELCO 902

Sharpening tool
Sharpening stone



FELCO 903

Sharpening tool
Sharpener



FELCO 910

Holster
Leather - With belt loop and clip



FELCO 912

Holster
Leather - With belt clip



FELCO 913

Holster
In mock leather - With belt loop



FELCO 980

Maintenance product
Spray









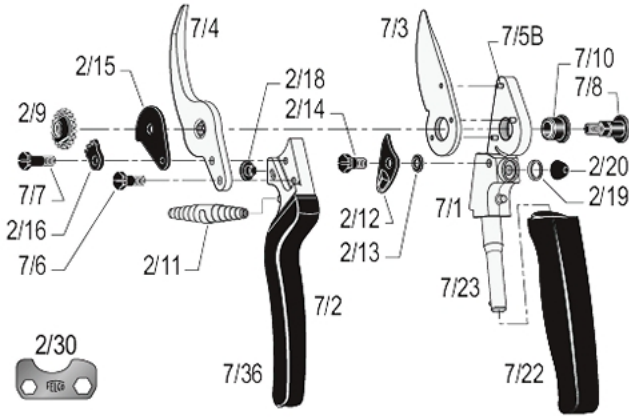

























FELCO 990

Maintenance product
Grease

Spare parts



	REF.	Designation	Composition	UCC bar code
	2/30	Adjustment key	1x 2/30	
	7/3	Blade	1x 7/3	
	7/4	Anvil-blade with screw	1x 7/4 + 1x 7/6	
	7/90	Kit	1x 7/7 + 1x 2/16 + 1x 2/9 + 1x 7/8	
	2/91	Kit	2x 2/11	
	2/92	Kit	1x 2/15 + 1x 2/18 + 1x 2/14 + 1x 2/12 + 1x 2/13 + 1x 2/20	
	2/93	Kit	4x 2/18 + 6x 2/20	
	7/94	Kit	1x 2/9 + 1x7/8	
	7/1	Handle without blade	1x 7/1 + 1x 7/23+ 3x 7/5B + 1x 2/19 + 1x 2/20 + 1x 7/10 + 1x 2/13 + 1x 2/12 + 1x 2/14	

	7/2	Handle without anvil-blade	1x 7/2 + 1x 2/18 + 1x 7/36
	7/22	Revolving handle	1x 7/22
	7/23	Axis for revolving handle	1x 7/23
	7/36	Plastic coating for anvil-blade / anvil handle	1x 7/36
	7/5B	Rivet for blade	1x 7/5B
	7/6	Screw for anvil-blade	1x 7/6
	7/8	Bolt	1x 7/8
	2/9	Nut	1x 2/9
	7/10	Bush	1x 7/10
	2/11	White spring	1x 2/11
	2/12	Thumb catch	1x 2/12
	2/13	Spring for thumb catch	1x 2/13
	2/14	Screw for thumb catch	1x 2/14
	2/15	Catch plate	1x 2/15
	2/16	Locking segment	1x 2/16
	7/7	Screw for locking segment	1x 7/7
	2/18	Cushion	1x 2/18



2/19

Edging

1x 2/19



2/20

Shock absorber

1x 2/20

Maintenance



Cleaning

It is advisable to clean your tool after each use.

If your tool is particularly dirty or subject to rusting after exposure to moisture, do not delay cleaning.



Oiling

After cleaning, it is advisable to oil the tool so as to protect it from corrosion. The oil will also unjam the tool.



Sharpening

It is advisable to sharpen your tool at least once a day, but if you feel that your tool is not cutting as well as usual, sharpen it right away!



Dismantling

It is advisable to dismantle your tool on a regular basis, but at the very latest when it appears to be jammed.



Dismantling the revolving handle

It is advisable to dismantle the revolving handle on a regular basis, so that it does not become jammed.

Replacement parts



Changing the blade

When the blade and the anvil-blade no longer cross, or when the blade is badly damaged, it is advisable to change it.

Regulate the working of the blade and anvil-blade by adjusting the tightening of the nut. The blade should rub against the anvil-blade over 2/3 of its length.



Changing the anvil-blade

When the blade and anvil-blade no longer cross and the anvil-blade is badly damaged, it is advisable to change it.



Changing the shock absorber

When the tool closes too abruptly during pruning, and the cushion is in good condition, the shock absorber should be changed.



Changing the cushion

When the tool closes too abruptly during pruning and the shock absorber is in good condition, the cushion must be changed.



Changing the thumb catch

When the thumb catch is damaged and loosens when used, even when the screw is readjusted, change it.



Changing the plastic coatings for handles

If the coatings are badly damaged, you can replace them.

Soak the coatings for 2 minutes in boiling water - recommended glue: Loctite 415.